

Descrizione / Description / Beschreibung

Levigatrice a nastro - Ponceuse a bande - Bandschleifmaschine

Art.
504

Cod. / Kode
8266132

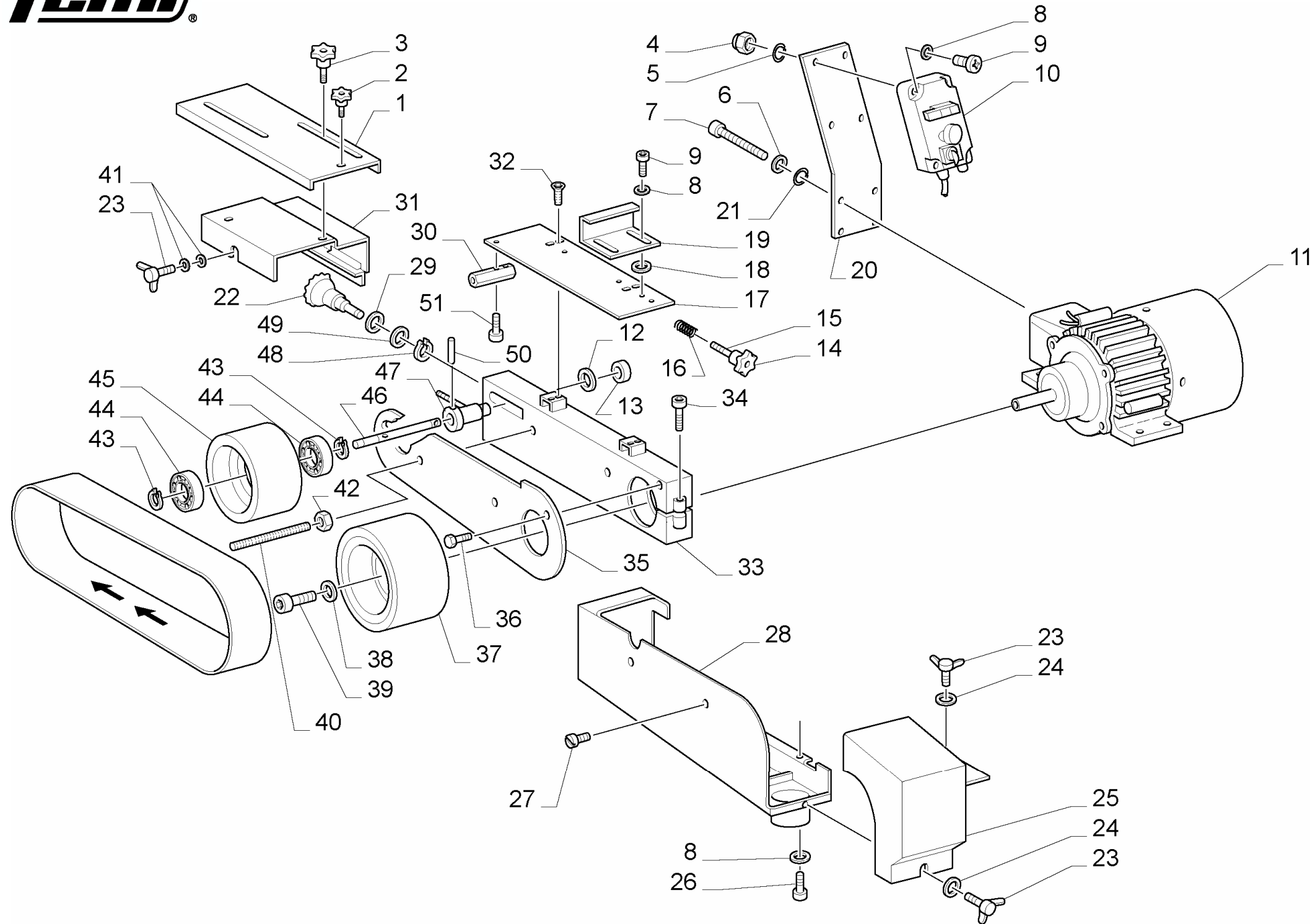

POS.	COD./KOD.	NOTE/MERKE/NOTES/NOTA/NOTAS
1	5.18.17.19	
2	0.14.00.63	
3	0.14.00.64	
4	0.10.21.06	
5	0.12.02.06	
6	0.12.01.05	
7	0.31.05.60	
8	0.12.01.06	
9	0.32.06.16	
10	7.80.02.23	
11	7.80.18.02	
12	0.12.40.20	
13	0.10.61.25	
14	0.14.00.01	
15	0.41.06.42	
16	5.08.01.12	
17	5.13.03.56	
18	0.12.07.13	
19	5.13.03.53	
20	5.13.77.83	
21	0.12.02.05	
22	5.14.00.23	
23	0.10.70.05	
24	0.12.08.06	
25	5.18.22.77	
26	0.32.06.12	
27	0.32.05.10	
28	5.18.17.16	
29	0.12.11.17	
30	5.12.15.59	
31	5.18.17.18	
32	0.38.06.20	
33	5.13.78.97	
34	0.32.10.45	
35	5.18.17.17	
36	0.31.10.16	
37	5.21.40.10	
38	0.12.90.02	
39	0.32.08.20	
40	5.12.20.13	
41	0.12.06.08	
42	0.10.01.10	
43	0.15.11.17	
44	0.52.63.03	
45	5.21.42.13	
46	5.00.20.48	
47	5.13.06.98	
48	0.15.11.15	
49	5.12.06.14	
50	0.15.28.45	
51	0.32.06.20	