

Descrizione / Description / Beschreibung

Levigatrice a nastro - Ponceuse a bande - Bandschleifmaschine

Art.
505B

Cod. / Kode
8266231

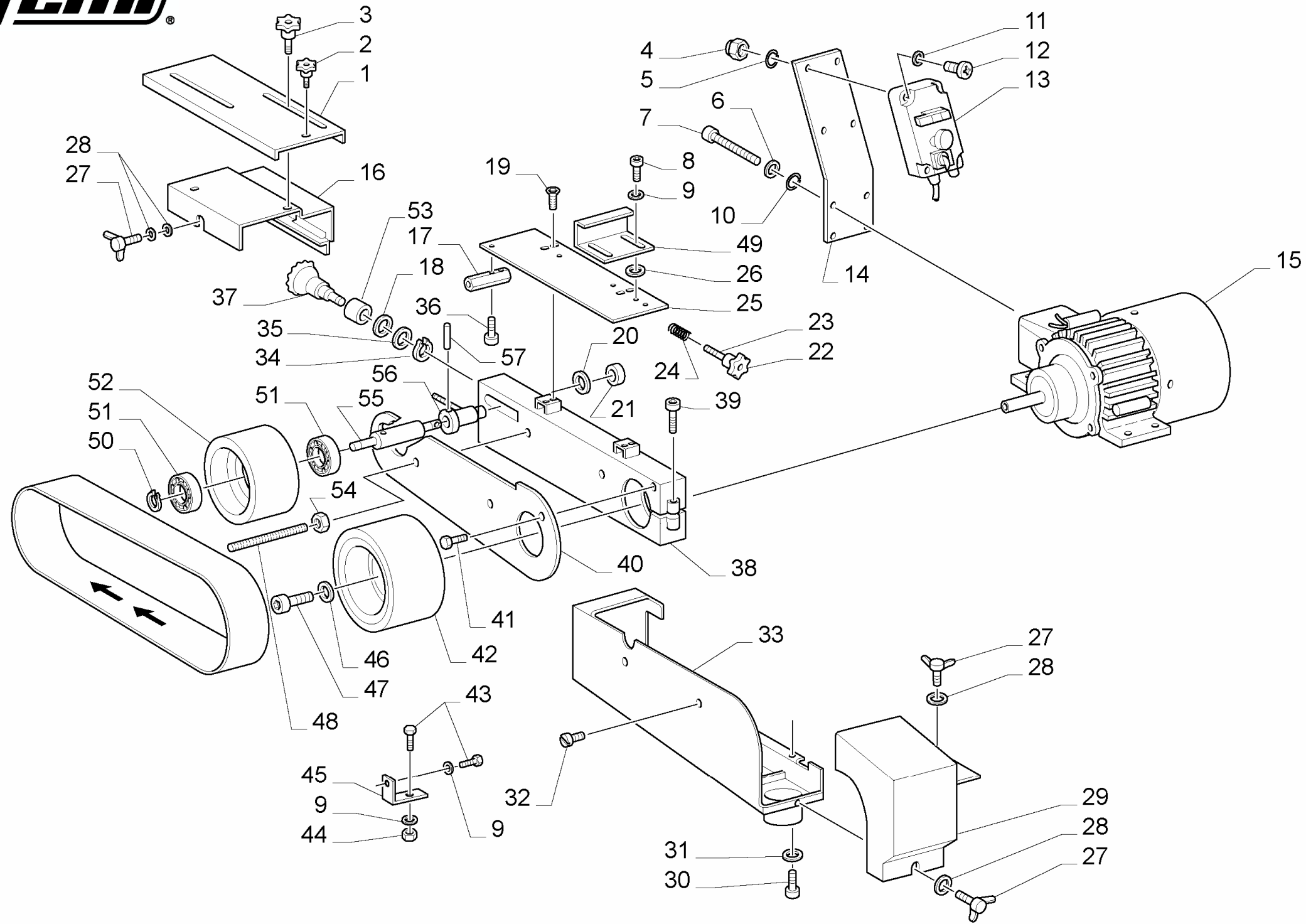

POS.	COD./KOD.	NOTE/MERKE/NOTES/NOTA/NOTAS
1	5.18.17.13	
2	0.14.00.63	
3	0.14.00.64	
4	0.10.21.06	
5	0.12.02.06	
6	0.12.01.05	
7	0.31.05.60	
8	0.32.08.20	
9	0.12.01.08	
10	0.12.02.05	
11	0.12.01.06	
12	0.32.06.16	
13	7.80.02.21	
14	5.13.77.83	
15	7.80.18.03	
16	5.18.17.12	
17	5.12.15.59	
18	0.12.11.17	
19	0.38.08.20	
20	5.12.40.23	
21	0.10.61.35	
22	0.14.00.40	
23	0.41.08.60	
24	5.08.01.11	
25	5.13.03.57	
26	0.12.07.14	
27	0.10.70.05	
28	0.12.08.06	
29	5.18.22.76	
30	0.32.06.10	
31	0.12.01.06	
32	0.32.05.10	
33	5.18.17.10	
34	0.15.11.15	
35	5.12.06.14	
36	0.32.06.20	
37	5.14.00.24	
38	5.13.78.96	
39	0.32.10.45	
40	5.18.17.11	
41	0.31.10.16	
42	5.21.40.11	
43	0.31.08.16	
44	0.10.01.08	
45	5.13.04.04	
46	0.12.90.02	
47	0.32.10.20	
48	5.12.20.14	
49	5.13.03.54	
50	0.15.11.17	
51	0.52.63.03	
52	5.21.42.14	
53	5.06.10.32	
54	0.10.01.10	
55	5.00.20.50	
56	5.13.06.99	
57	0.15.06.11	