

Levigatrice combinata nastro / disco - Ponceuse a bande/disco
Kombinierte band - und scheibenschleifmaschine



Art.
534B

Cod. / Kode
8286131

Pag.
1/2

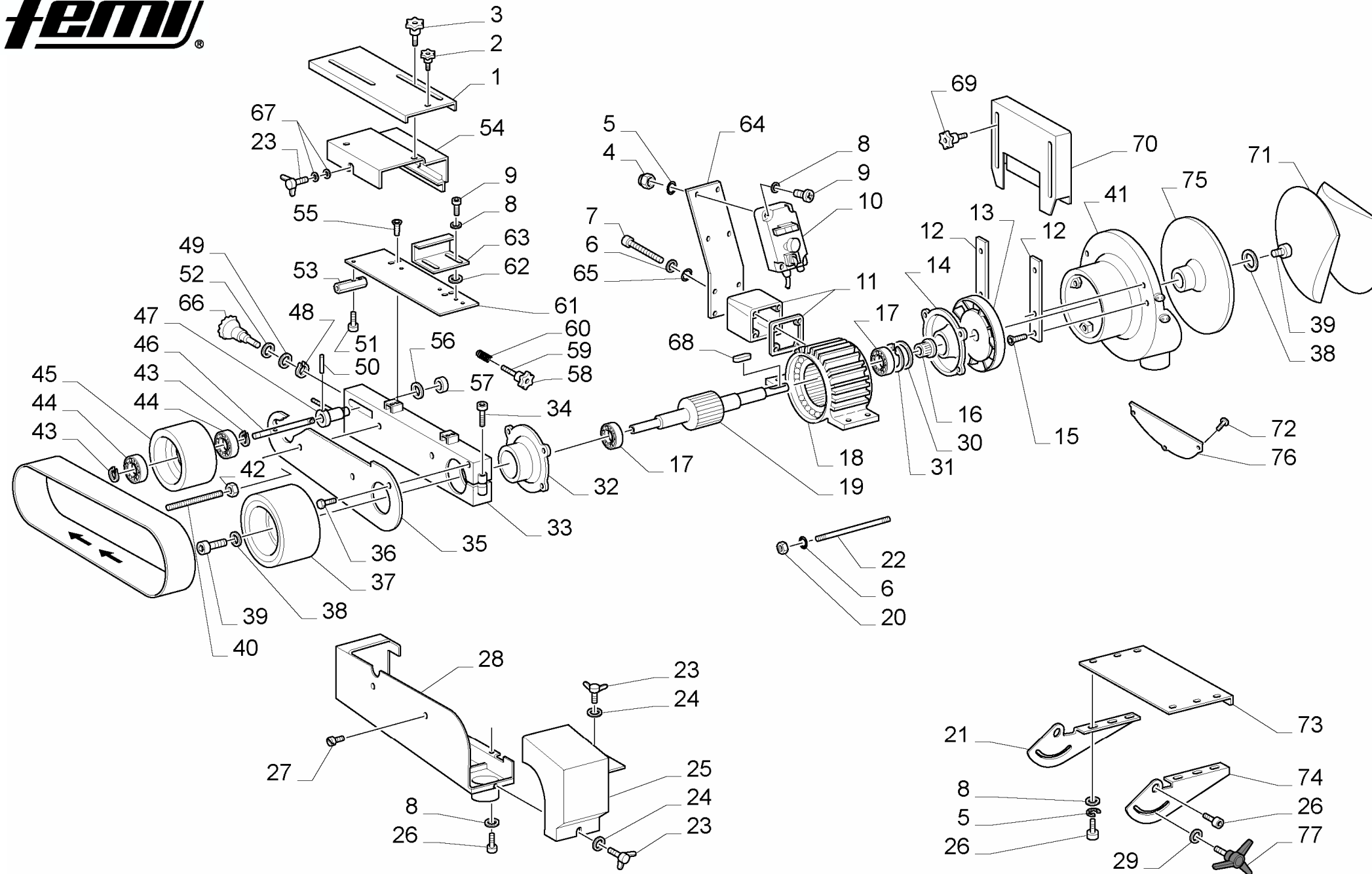

POS.	COD./KOD.	NOTE/MERKE/NOTES/NOTA/NOTAS
1	5.18.17.19	
2	0.14.00.63	
3	0.14.00.64	
4	0.10.21.06	
5	0.12.02.06	
6	0.12.01.05	
7	0.31.05.60	
8	0.12.01.06	
9	0.32.06.16	
10	7.80.02.38	
11	0.04.25.49	
12	5.13.08.10	
13	0.11.20.11	
14	5.04.27.57	
15	0.38.08.15	
16	5.12.06.29	
17	0.52.62.04	
18	7.80.10.69	
19	7.01.36.12	
20	0.10.07.05	
21	5.13.03.32	
22	5.17.30.29	
23	0.10.70.05	
24	0.12.08.06	
25	5.18.22.77	
26	0.32.06.12	
27	0.32.05.10	
28	5.18.17.16	
29	0.12.01.10	
30	0.15.50.04	
31	0.15.51.04	
32	5.04.27.56	
33	5.13.78.97	
34	0.32.10.45	
35	5.18.17.17	
36	0.31.10.16	
37	5.21.40.10	
38	0.12.90.02	
39	0.32.08.20	
40	5.12.20.13	
41	5.18.05.22	
42	0.10.01.10	
43	0.15.11.17	
44	0.52.63.03	
45	5.21.42.13	
46	5.00.20.48	
47	5.13.06.98	
48	0.15.11.15	
49	5.12.06.14	
50	0.15.28.45	
51	0.32.06.20	
52	0.12.11.17	
53	5.12.15.59	
54	5.18.17.18	
55	0.38.06.20	
56	0.12.40.20	
57	0.10.61.25	
58	0.14.00.01	
59	0.41.06.42	
60	5.08.01.12	